

La construction d'une yourte :

①

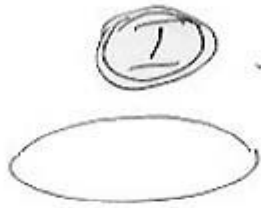

① Le plancher

②

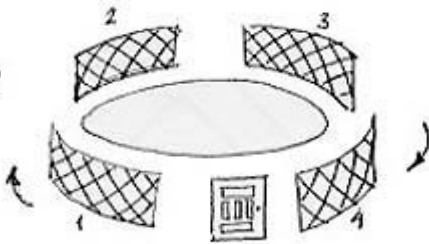

② les murs (4)

③

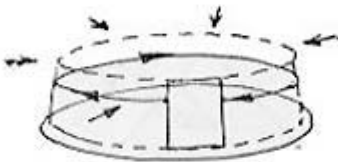

④

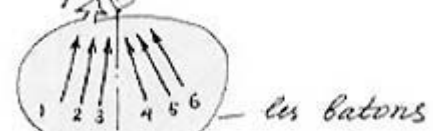
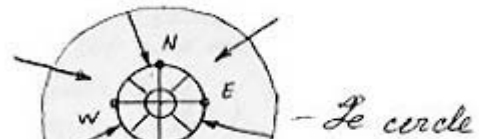
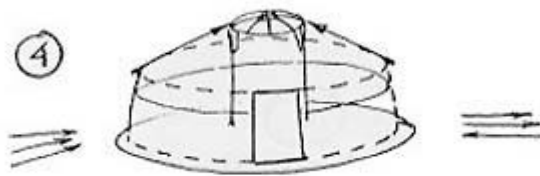

(N° I-1, I-2, I-3, ...
II-1, II-2, II-3, ...
...)

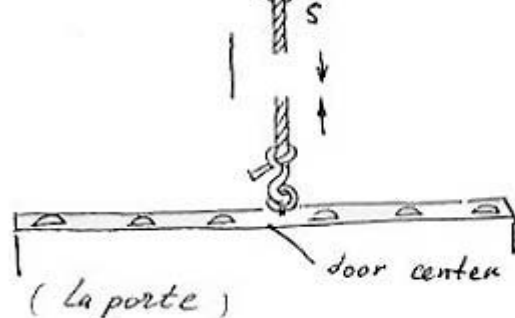

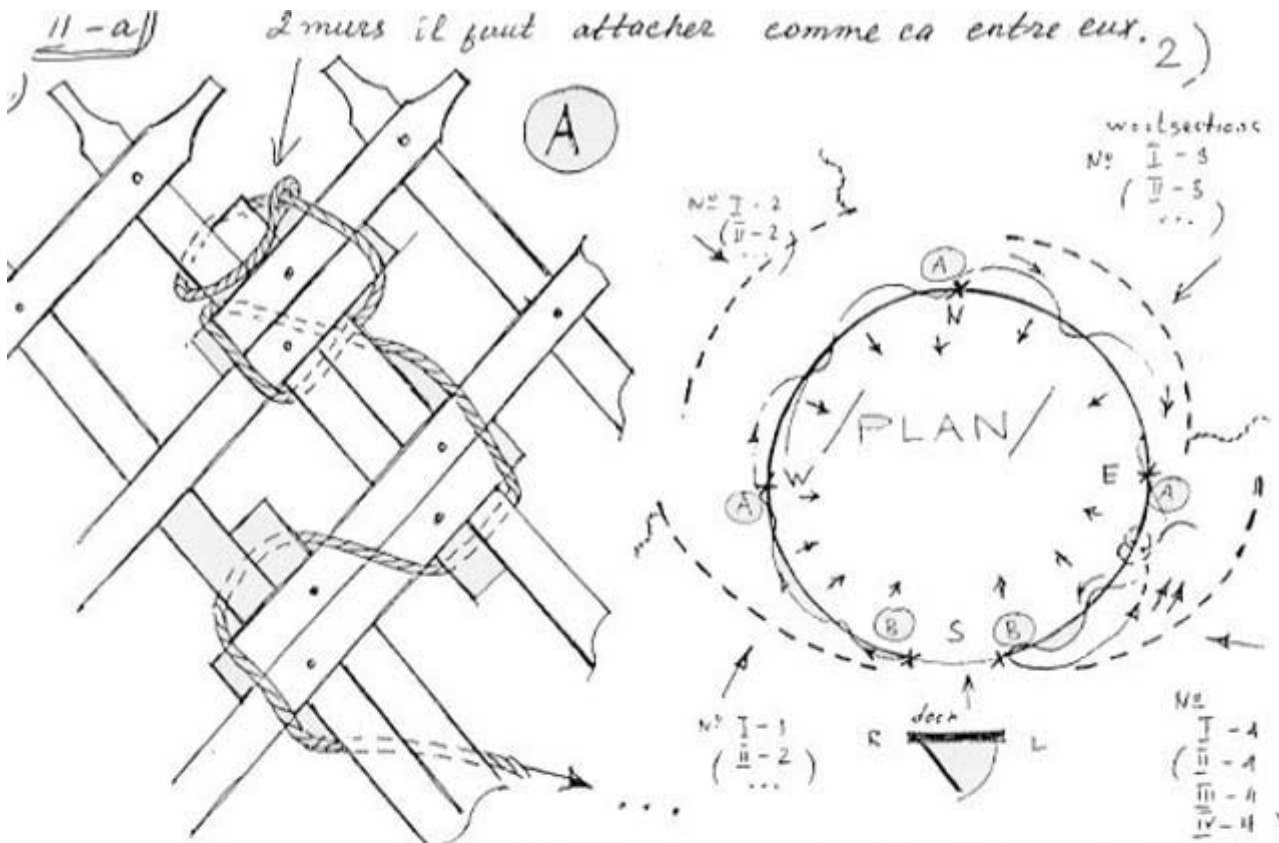

Qu'il y a une seule ceinture intérieure
Il est une ~~cord~~ ^{fil} simple.
C'est pour bien tenir les bois. (B)

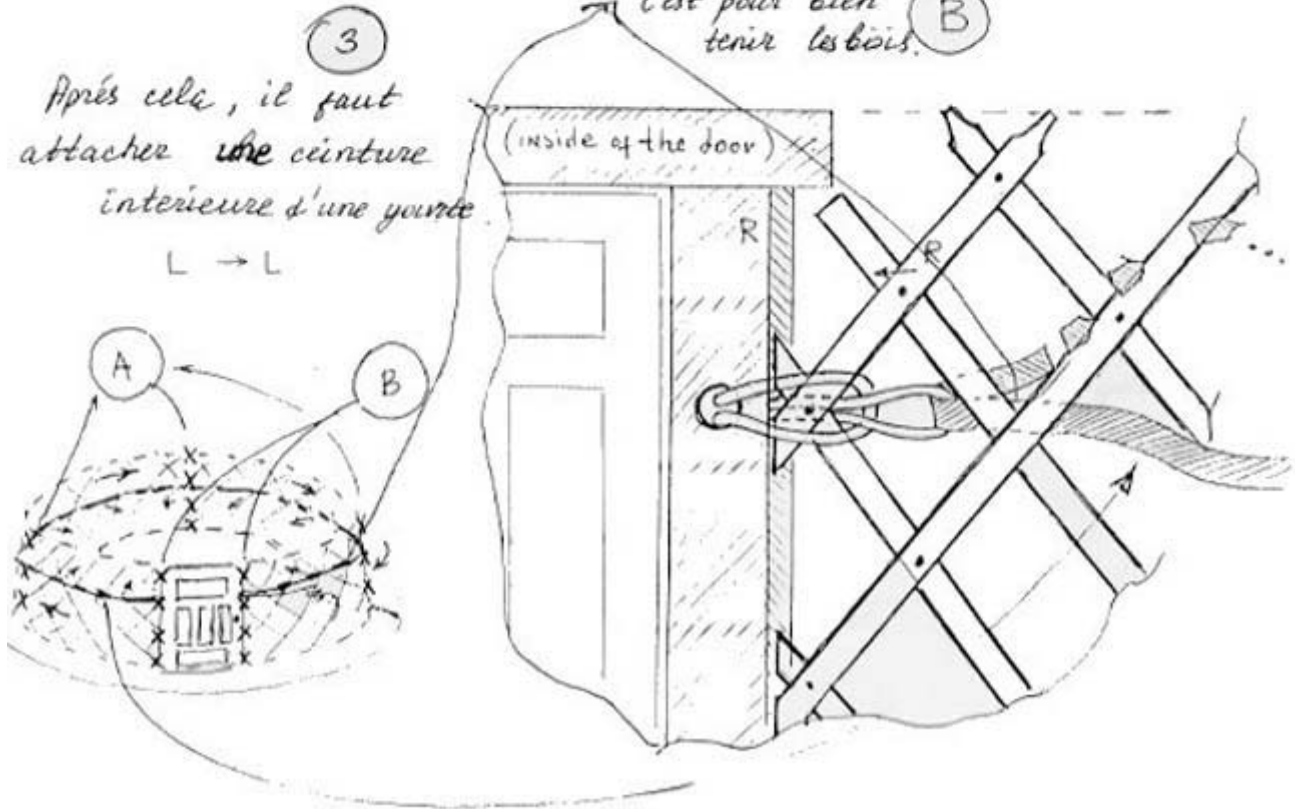

⑤ Calibration / Correction!

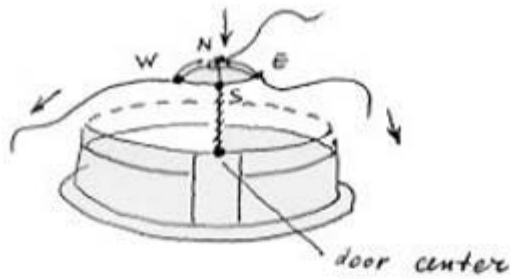

make and maintain
a balance,
using S (+N, W, E)
and door center

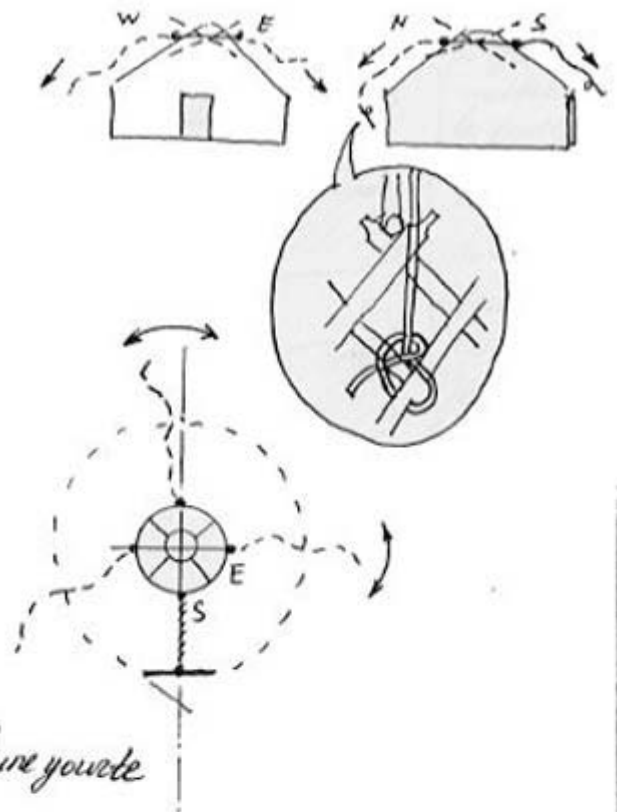

⑥ Le tissu de l'intérieure d'une yourte

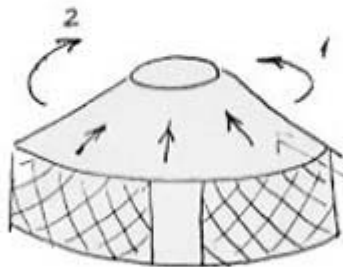

Après la construction des
bois d'une yourte
il faut mettre

le tissu blanc de l'intérieure
d'une yourte

(Pour une yourte, il
est qu'une seule)

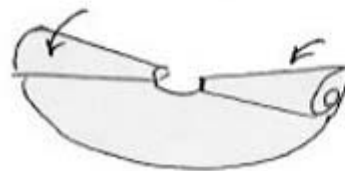
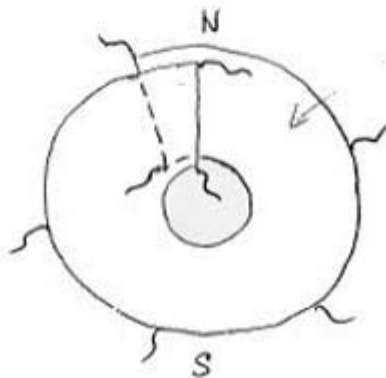

7

III) les feutres d'une youate

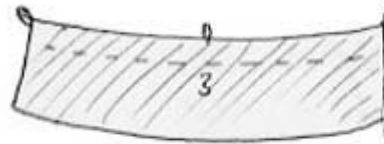
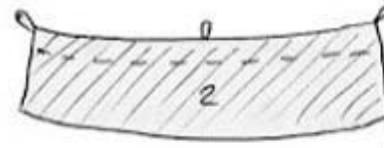
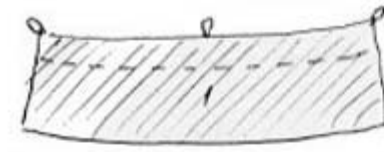
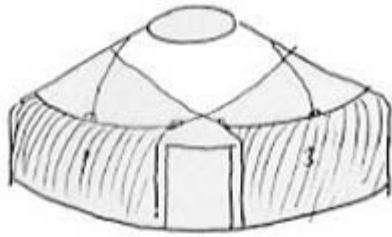

Et après il faut mettre les feutres.

Une youate a 3 parties - feutres comme ça; c'est autour d'une youate. En plus après

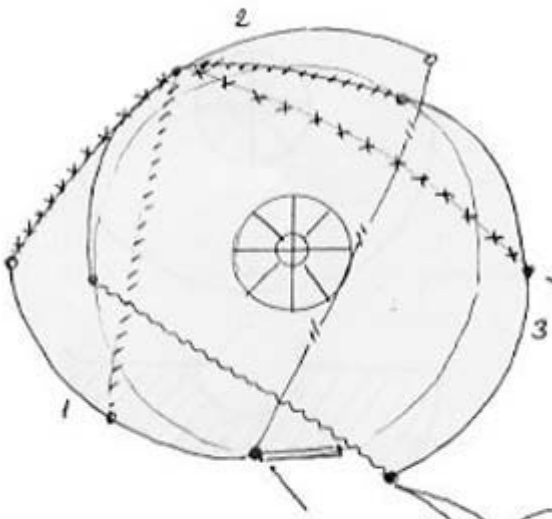

les cordes (fil, ficels)

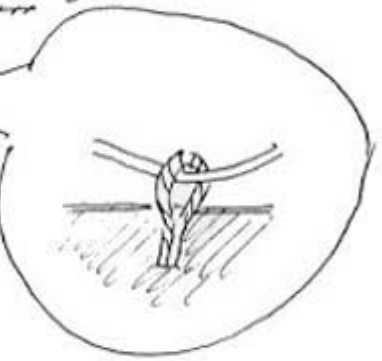
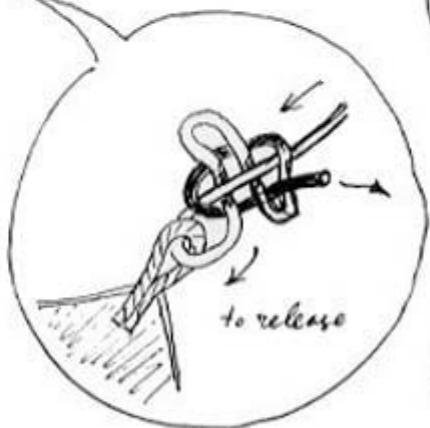

If faut attacher entre eux par les cordes.

8

10

Les feutres aussi

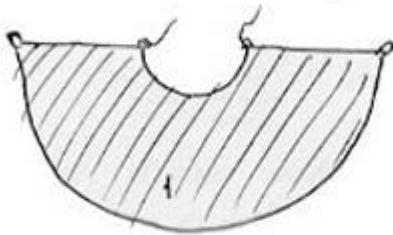
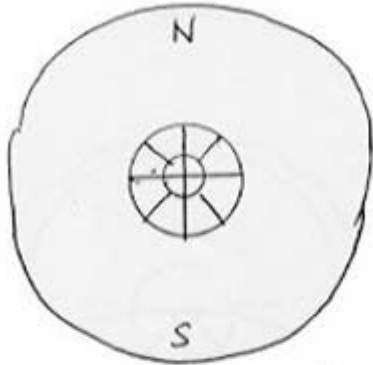
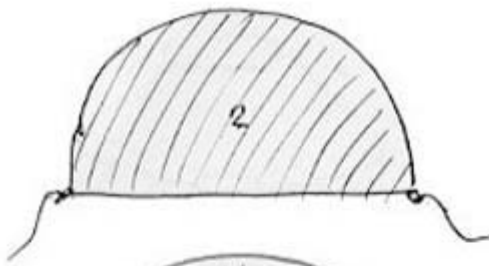

Une yourte a 2 parties -
feutres comme ca.
C'est les feutres, qu'ils
doivent mettre
au dessus
d'une
yourte.

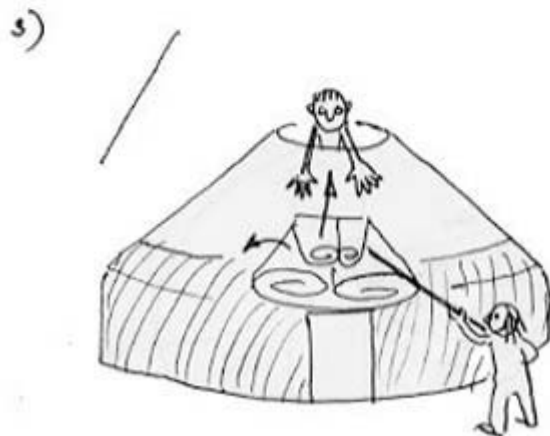
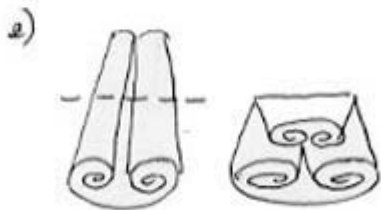
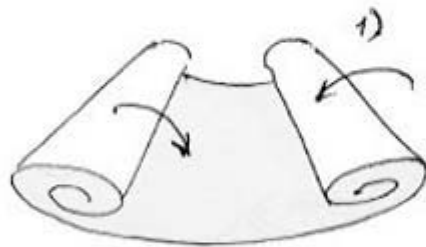

⑨ ^{toiles} (V) les trois verts (parfois blanc) ~~solide~~ d'armée russe
solide, qui protège de la pluie.
Après, il faut mettre,

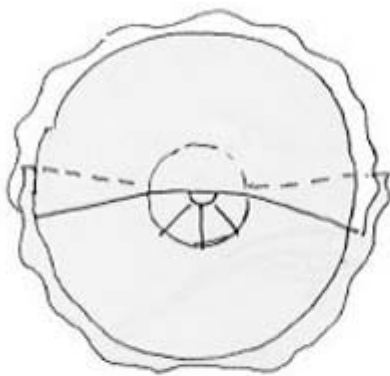
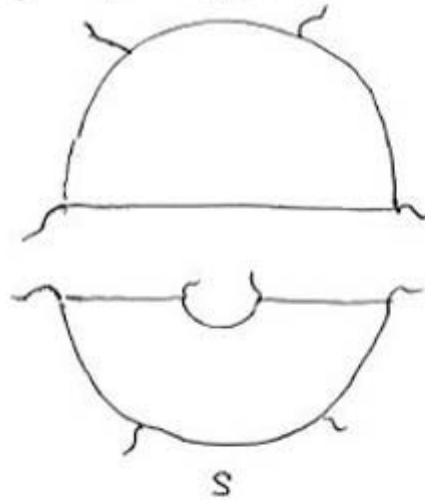
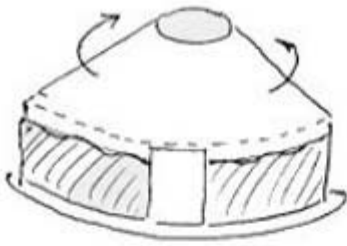

⑩ Après, il faut mettre
le tissu extérieur (blanc / fin)
toile

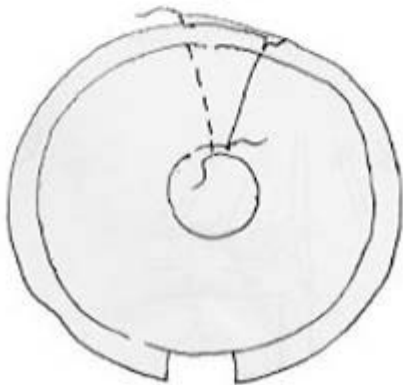
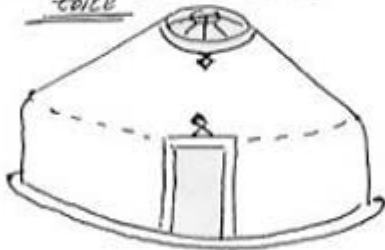

⑪

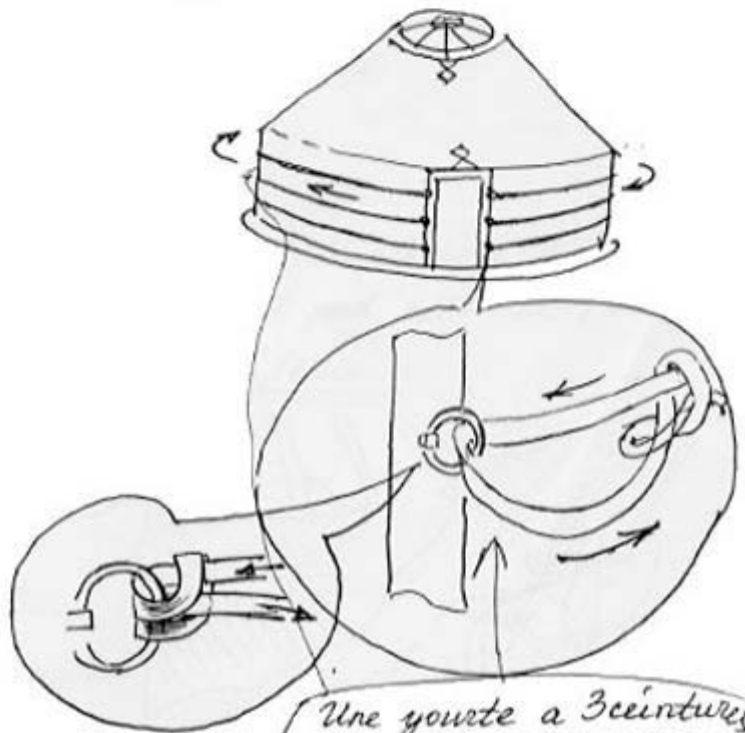

Une ceinture a 3 ceintures
extérieures, et il faut
attacher comme ça ⑨

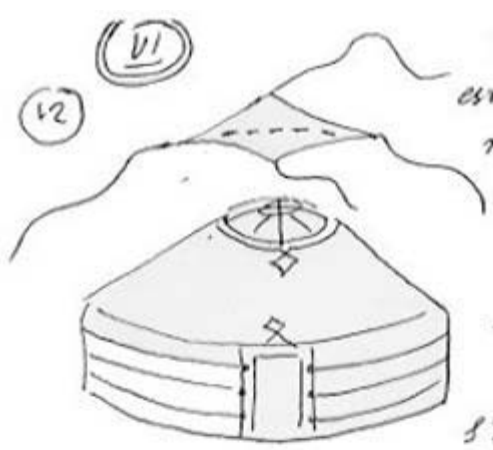

Une yourte est prête, maintenant il faut mettre

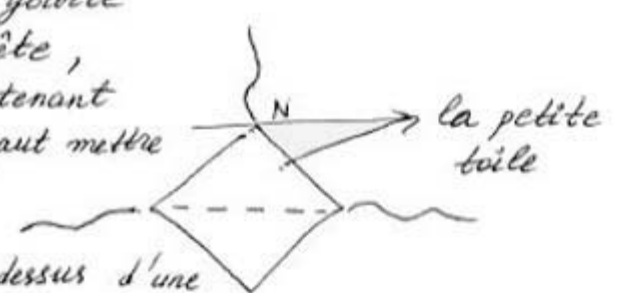

au-dessus d'une yourte.

s'il fait froid ou } S
s'il pleut il faut couvrir!

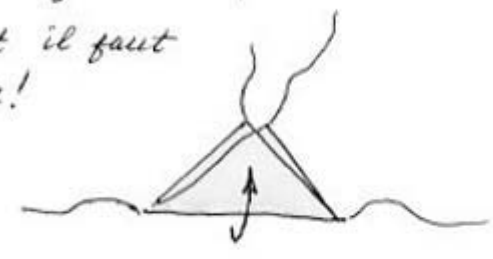

Il faut tacher (comme ça; 2 côtés et derrière)

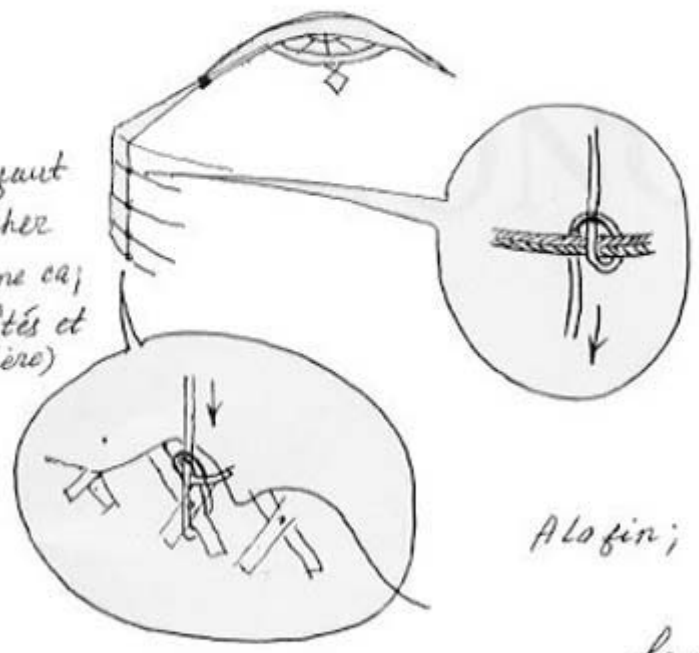

A la fin; à l'intérieure d'une yourte il faut attacher / mettre le rideau.

